

# M6169 SERIES

## SINGLE-OUTPUT, UP TO 1KW AC/DC POWER SUPPLY, BASE PLATE COOLED

The M6169 converts universal input voltage (85V ac to 265V ac) to DC Output at 1kW.

This unit is sealed to protect against fluids.

This unit can tolerate high level of shocks and vibration.

This unit meets RE102 (24bd $\mu$ V/m) as required by MIL-STD-461



### THE MAIN FEATURES OF THE M6169 ARE:

- AC/DC Single output power supply up to 1kW
- 85V<sub>AC</sub>-265V<sub>AC</sub>/50-60Hz or 90V<sub>AC</sub>-180V<sub>AC</sub> / 400Hz Standard Input version, single-phase
- For extended input version - **Please contact factory for more details**
- High efficiency
- Wide input range
- High power factor
- Input / Output isolation
- Optional - Remote sense compensation
- Can be configure as a charger- **Please contact factory for more details**
- EMI filters included
- Was subject to RE102 and CE102 tests IAW MIL-STD-461
- Inrush Current Limiter
- Sustains high level of shocks and vibration, salt-fog, blowing rain, sand and dust.
- Sealed enclosure
- Non-latching protections:
  - Overload/Short-circuit
  - Output Overvoltage
  - Over Temperature

## M6169 Series– AC/DC Power Supply

### Standard Models List (for other voltages – consult factory)

Part number	Input		Output		Special features	type	
	Voltage range	Frequency	Voltage	Current		A	B
M6169-100	85V <sub>AC</sub> -265V <sub>AC</sub> / 1-phase	50/60/400Hz	5 V <sub>DC</sub>	42 A	Vout ±2%	V	
M6169-101	85V <sub>AC</sub> -265V <sub>AC</sub> / 1-phase	50/60/400Hz	12 V <sub>DC</sub>	42 A	Vout ±2%	V	
M6169-102	85V <sub>AC</sub> -265V <sub>AC</sub> / 1-phase	50/60/400Hz	24 V <sub>DC</sub>	42 A	Vout ±2%	V	
M6169-103	85V <sub>AC</sub> -265V <sub>AC</sub> / 1-phase	50/60/400Hz	28 V <sub>DC</sub>	36 A	Vout ±2%	V	
M6169-104	85V <sub>AC</sub> -265V <sub>AC</sub> / 1-phase	50/60/400Hz	48 V <sub>DC</sub>	21 A	Vout ±2%	V	
M6169-106	85V <sub>AC</sub> -265V <sub>AC</sub> / 1-phase	50/60/400Hz	28 V <sub>DC</sub>	36 A	Parallel operation via output voltage droop. Voltage regulation is ±2%. Vout ±2%	V	
M6169-200	85V <sub>AC</sub> -265V <sub>AC</sub> / 1-phase	50/60/400Hz	5 V <sub>DC</sub>	42 A			V
M6169-201	85V <sub>AC</sub> -265V <sub>AC</sub> / 1-phase	50/60/400Hz	12 V <sub>DC</sub>	42 A			V
M6169-202	85V <sub>AC</sub> -265V <sub>AC</sub> / 1-phase	50/60/400Hz	24 V <sub>DC</sub>	42 A			V
M6169-203	85V <sub>AC</sub> -265V <sub>AC</sub> / 1-phase	50/60/400Hz	28 V <sub>DC</sub>	36 A			V
M6169-204	85V <sub>AC</sub> -265V <sub>AC</sub> / 1-phase	50/60/400Hz	48 V <sub>DC</sub>	21 A			V

- Additional standard configurations available. **Contact factory for more details.**
- All of our products can be configured to comply with EU REACH regulations. **Contact factory for more details.**

**SPECIFICATIONS:**

<b>AC Input</b>	<b>Voltage Range</b>	Option 1: 85 V <sub>AC</sub> -265 V <sub>AC</sub> /50 Hz - 60 Hz / Single-phase Option 2: 90 V <sub>AC</sub> -180 V <sub>AC</sub> /400 Hz / Single-phase For extended input version - <b>Please contact factory for more details</b>
	<b>Isolation</b>	1 000 V <sub>DC</sub> Input to Output 1 000 V <sub>DC</sub> Input and Case
	<b>Spikes</b>	<b>Optional</b> to withstand 1000 V spikes IAW MIL-STD-1399-300B. <b>please consult factory</b>
<b>DC Output</b>	<b>Rating</b>	1 kW, models with nominal output voltage of up to 48VDC and rated current up 36Amp are available (see the Standard Models List on Page 3).
	<b>Voltage Regulation</b>	Up to ±2% (no load to full load, –40 °C to +85 °C and over normal input voltage range).
	<b>Optional Remote Sense</b>	The SENSE is used to achieve accurate load regulations at load terminals (this is done by connecting the pins directly to the load’s terminals). For output voltage above 8V, the use of remote sense has a max limit of 0.25V voltage dropout between converter’s output and load terminals. For output voltage below 8V, the use of remote sense has a max limit of 0.5V voltage dropout between converter’s output and load terminals. When not used connect SENSE to OUT and SENSE RTN to OUT RTN.
	<b>Ripple and Noise</b>	(max. 1%) measured at load across 1 µF and 0.1 µF ceramic capacitors.
	<b>Isolation</b>	200 V <sub>DC</sub> Output and Case
	<b>Current Limit &amp; Overload</b>	Output turns off and on periodically (hiccup) until fault is condition removed. Protection threshold set at 120% ± 10% of maximum current <b>Optional:</b> Continuous protection (10 to 30% above maximum current) for unlimited time. <b>please consult factory</b>
	<b>Efficiency</b>	Up to 85-89% - typical (nominal input voltage, full load, room temperature)
	<b>Overvoltage Protection</b>	<ul style="list-style-type: none"> <li>• <b>Active Over-Voltage Protection</b> Internal control shuts output down if voltage exceeds 110% ± 5% of nominal.</li> <li>• <b>Passive Over-Voltage Protection</b> A transorb, rated to 120% ± 10% of nominal voltage, is placed across the output.</li> </ul>
<b>Over Temp. Protection</b>	Unit shuts down if baseplate temperature exceeds 100 ± 5 °C. Automatic recovery upon cooldown to below 95 ± 5 °C.	

Specifications (Cont.):

<b>Environment Designed to meet MIL-STD-810F</b>	<b>Temperature</b>	Methods 501.4 & 502.4 Operating: -40 °C to +85 °C (at baseplate). Optional operating -55 please consult factory. Storage: -55 °C to +125 °C (ambient)
	<b>Humidity</b>	Method 507.6 test Procedure 2
	<b>Rain</b>	Method 506.6 Procedure 1,2
	<b>Sand &amp; Dust</b>	Method 510.6 Procedure 1
	<b>Salt-fog</b>	Method 509.6
	<b>Altitude</b>	Method 500.4 Procedures I – up to 70,000 ft. (non-operational) Procedure II – up to 40,000 ft. (operational) Note: can be operational.
	<b>Temperature Shock</b>	Method 503.6
	<b>Mechanical Shock</b>	Method 516.5 Procedure I 30 g, 11 ms terminal peak saw-tooth
	<b>*See note page 6 Vibration</b>	Method 514.5 Procedure I Category 24 - General minimum integrity exposure
	<b>Temperature/ Altitude DE-RATING</b>	DE-RATE temperature linearly with altitude with a slope of - 9°C/ 5000 FT TBR referenced to the maximum hot operating temperature at MSL
	<b>Fungus</b>	Method 508.7
	<b>IP rating</b>	Designed to meet IP67
<b>EMI</b>	<b>Designed to meet* MIL-STD-461F</b>	CS101, CS114, CS115, CS116,, RS103 (50V/m), CE101-4 curve #1, RE101-1 and RS101.
	<b>Meet * MIL-STD-461F</b>	CE102-1 (115V limit), RE102 (24bdµV/m)
<b>Reliability</b>	150,000 hours, calculated per MIL-STD-217F Notice 2 at +85 °C baseplate, Ground Fixed environment.	
<b>Form factor</b>	7.25" wide, 3.1" high and 11" deep. For detailed dimensions and tolerances see Drawing: M6169001	
<b>Weight</b>	10.5 lb. Typical	

\* Compliance dependent on specific configuration and is achieved when using shielded output cables cable.

MEETS THE FOLLOWING VIBRATION PROFILES:

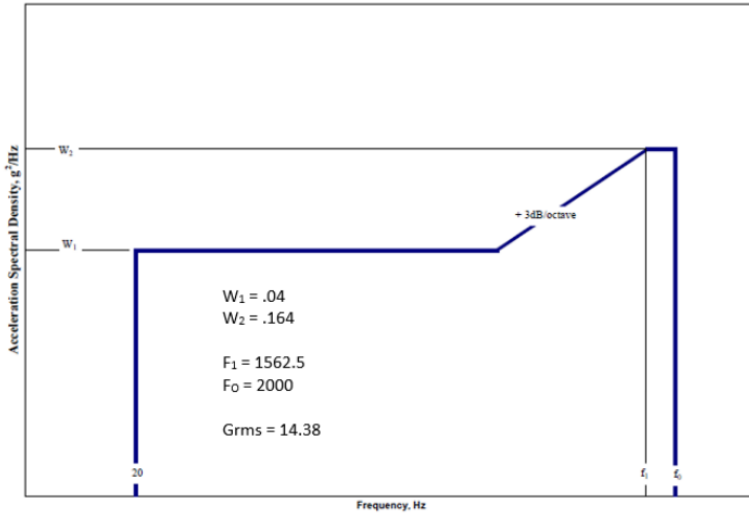

Figure 11 - Random Vibration Spectral Density Profile

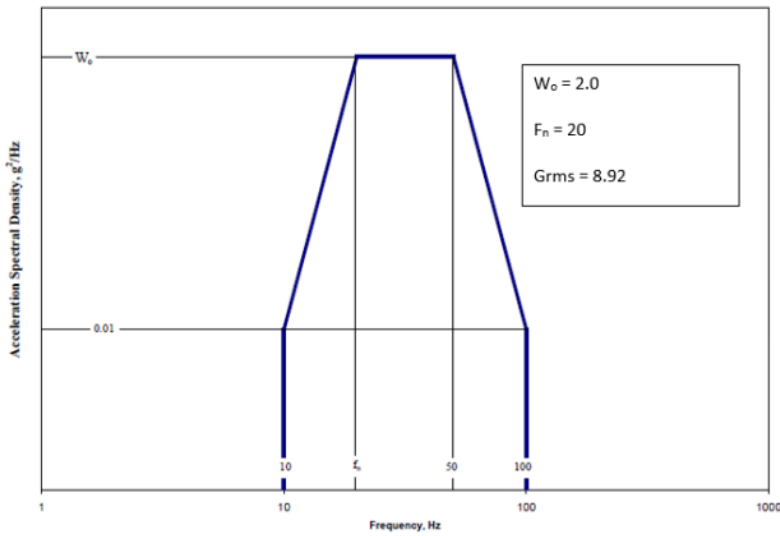
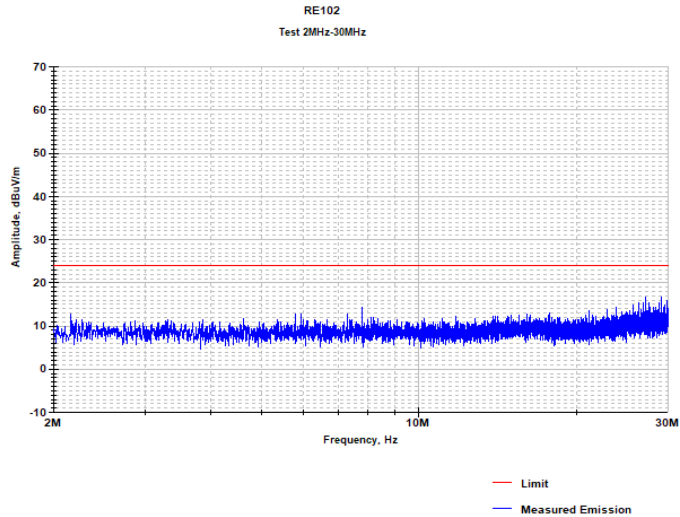

Figure 12 - Buffeting Vibration Spectral Density Profile

**TEST RESULTS RE102**

**Plot 1.2: RE102 test results within 2 – 30 MHz, vertical polarization**

Display line is Limit



**Plot 1. 4: RE102 test results within 30 – 200 MHz, vertical polarization**

Display line is Limit

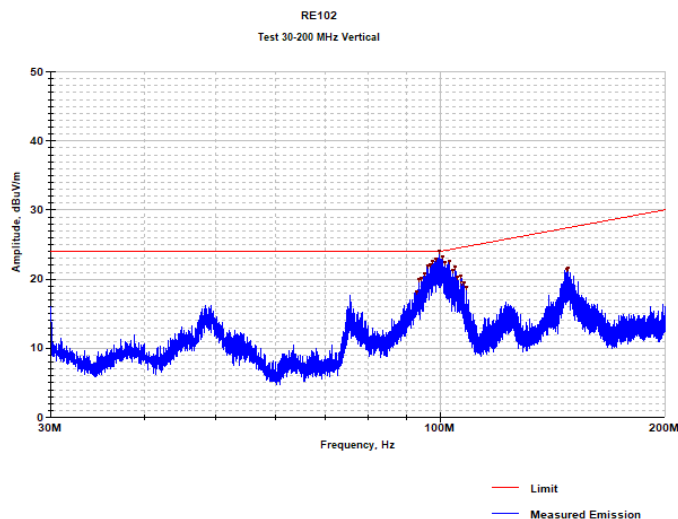

**Plot 11.15: RE102 test results within 30 – 200 MHz, horizontal polarization**

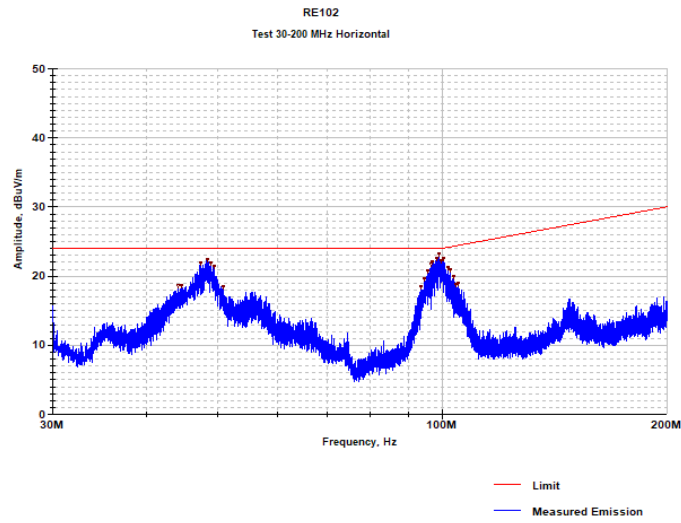

**Plot 11.19: RE102 test results within 200 – 1000 MHz, vertical polarization**

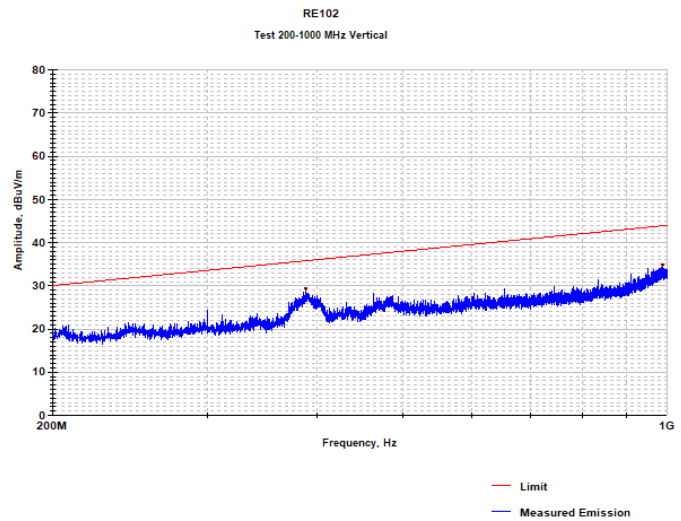

Display line is Limit

**Plot 11.21: RE102 test results within 200 – 1000 MHz, horizontal polarization**

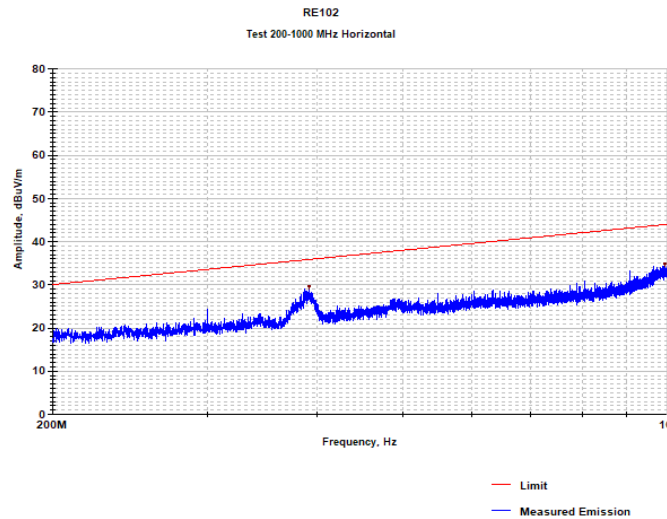

**Plot 11.25: RE102 test results within 1000 – 18000 MHz, vertical polarization**

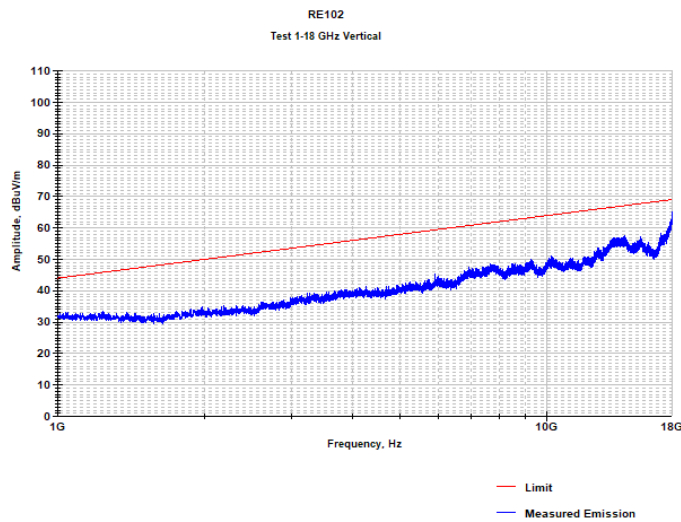

Display line is Limit

Plot 11.25: RE102 test results within 1000 – 18000 MHz, horizontal polarization

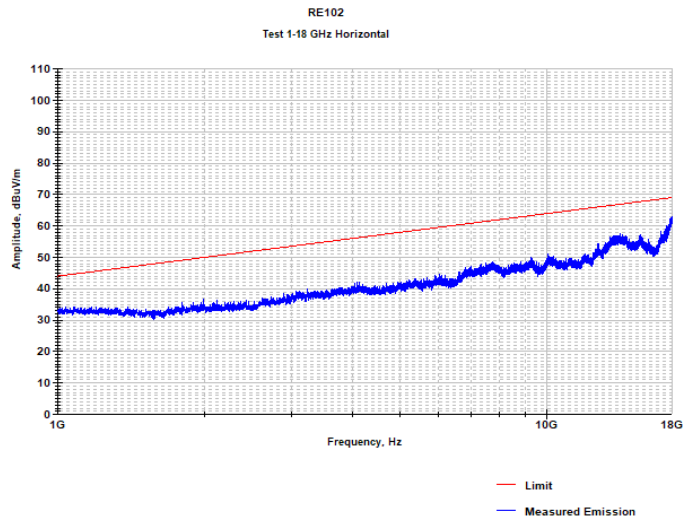

Display line is Limit

## M6169 Series– AC/DC Power Supply

RE102 test results within 30 – 200 MHz, vertical polarization

Frequency (MHz)	Measured Emission (dBuV/m)	Limit (dBuV/m)	Delta (dB)
92.713	18.10	24.00	-5.90
93.393	19.86	24.00	-4.14
94.277	20.14	24.00	-3.86
95.093	20.75	24.00	-3.25
96.215	21.91	24.00	-2.09
96.963	21.99	24.00	-2.01
97.660	22.48	24.00	-1.52
98.578	22.80	24.00	-1.20
99.445	24.00	24.00	-0.00
100.482	23.19	24.04	-0.85
101.179	22.37	24.10	-1.73
102.913	22.59	24.25	-1.66
103.950	21.24	24.34	-3.09
104.562	21.71	24.39	-2.68
105.174	20.27	24.44	-4.17
106.330	20.37	24.53	-4.16
106.942	19.39	24.58	-5.19
107.554	19.51	24.63	-5.12
108.336	18.75	24.69	-5.95
147.538	21.43	27.37	-5.94
148.286	21.57	27.41	-5.84

## M6169 Series– AC/DC Power Supply

RE102 test results within 30 – 200 MHz, horizontal polarization

Frequency (MHz)	Measured Emission (dBuV/m)	Limit (dBuV/m)	Delta (dB)
44.178	18.5	24.0	-5.5
44.688	18.5	24.0	-5.5
47.425	21.9	24.0	-2.1
48.326	22.5	24.0	-1.5
48.921	21.8	24.0	-2.2
49.431	21.4	24.0	-2.6
50.791	18.4	24.0	-5.6
93.665	18.4	24.0	-5.6
94.549	19.6	24.0	-4.4
95.433	20.8	24.0	-3.2
96.419	21.6	24.0	-2.4
96.929	22.1	24.0	-1.9
98.187	22.5	24.0	-1.5
98.901	23.1	24.0	-0.9
99.462	22.3	24.0	-1.7
100.397	22.5	24.0	-1.6
101.689	21.2	24.1	-2.9
102.267	20.9	24.2	-3.3
103.423	19.9	24.3	-4.4
104.239	18.7	24.4	-5.6
104.919	18.9	24.4	-5.5

**TEST RESULTS CE102**

**Plot 5.10: CE102 test results in 10 kHz-10.0 MHz range, PHASE 115 VAC**

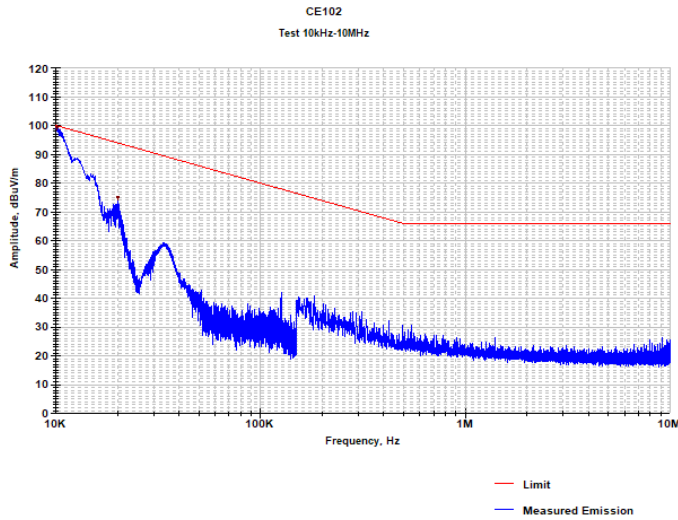

Display line is Limit

**Plot 5.12: CE102 test results in 10 kHz-10.0 MHz range, NEUTRAL 115 VAC**

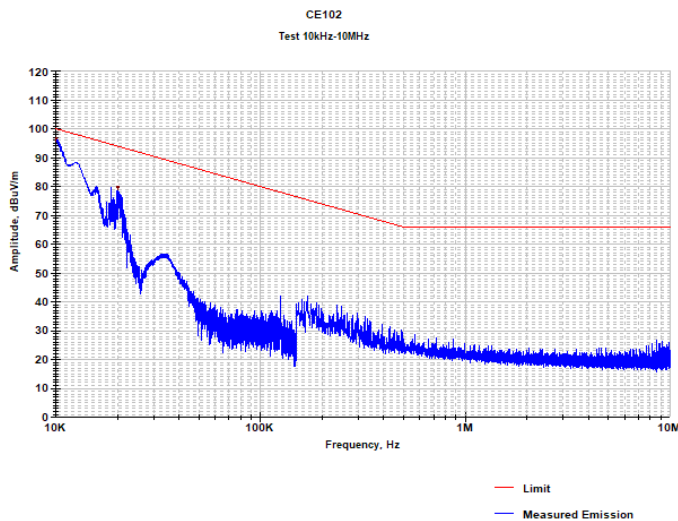

Display line is Limit

**PIN ASSIGNMENT: J1 - INPUT CONNECTOR**

**Connector type:** D38999/24WC4PN (4#16 PINS) or eq.

**Mates with:** D38999/26WC4SN or eq.

Pin #	Function
A	PHASE
B	NEUTRAL
C	CHASSIS GND
D	(SPARE) NOT CONNECT

**CHASSIS Note: Chassis PIN**

This pin is connected to the converter's chassis.

**PIN ASSIGNMENT: J2 - OUTPUT CONNECTOR - OPTION A**

**Connector type:** D38999/24WE6SN (6#12 SOCKETS) or eq.

**Mates with:** D38999/26WE6PN or eq.

Pin #	Function
A	VOUT
B	VOUT RTN
C	CHASSIS GND
D	VOUT
E	VOUT RTN
F	CHASSIS GND

**Note:** All pins with identical function/designation should be connected together for optimal performance.

**CHASSIS Note: Chassis PIN**

This pin is connected to the converter's chassis.

**PIN ASSIGNMENT: J2 - OUTPUT CONNECTOR - OPTION B**

**Connector type:** D38999/24WE6SN (6#12 SOCKETS) or eq.

**Mates with:** D38999/26WE6PN or eq.

Pin #	Function
A	VOUT
B	VOUT RTN
C	SENSE
D	VOUT
E	VOUT RTN
F	SENSE RTN

**Note:** All pins with identical function/designation should be connected together for optimal performance.

## PIN ASSIGNMENT: J2 - OUTPUT CONNECTOR - OPTION C

**Connector type:** D38999/24WE6SN (6#12 SOCKETS) or eq.

**Mates with:** D38999/26WE6PN or eq.

Pin #	Function
A	VOUT
B	VOUT RTN
C	VOUT
D	VOUT
E	VOUT RTN
F	VOUT RTN

Sense lines are tied internally

**Note:** All pins with identical function/designation should be connected together for optimal performance.

**BLOCK DIAGRAM – OPTION A**



**BLOCK DIAGRAM – OPTION B**

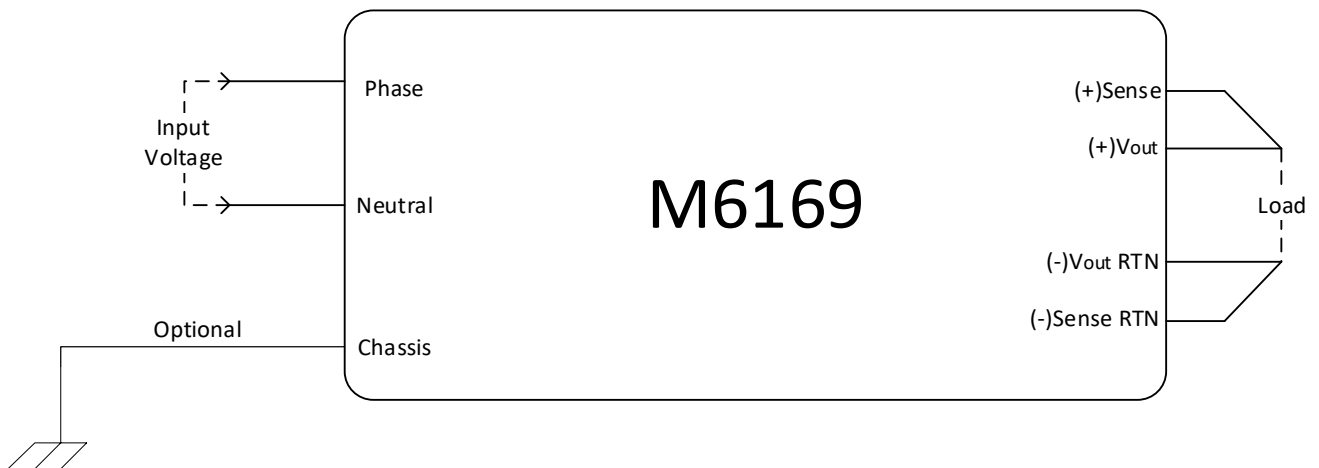

BLOCK DIAGRAM – OPTION C

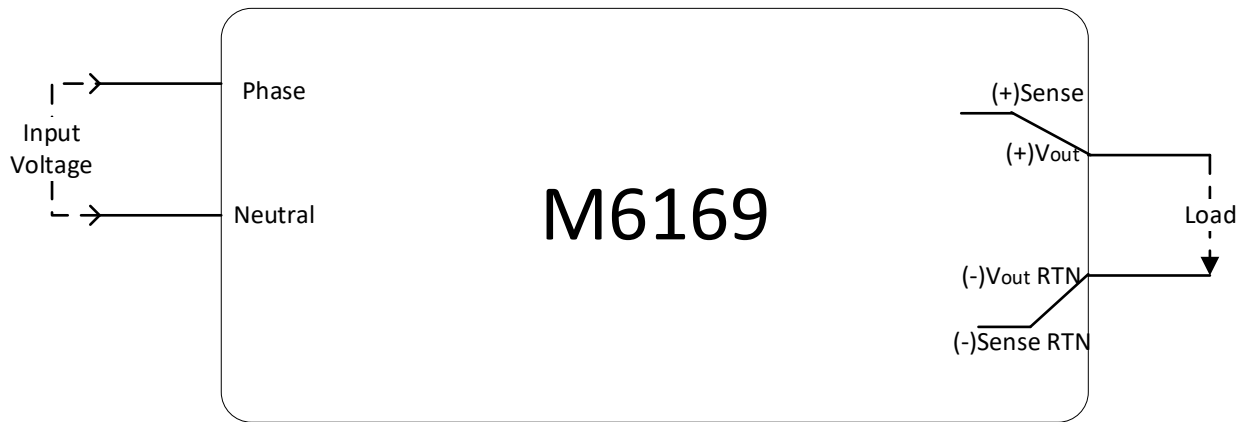

# M6169 Series– AC/DC Power Supply

## OUTLINE DRAWING:

For detailed dimensions and tolerances see Drawing: M6169001

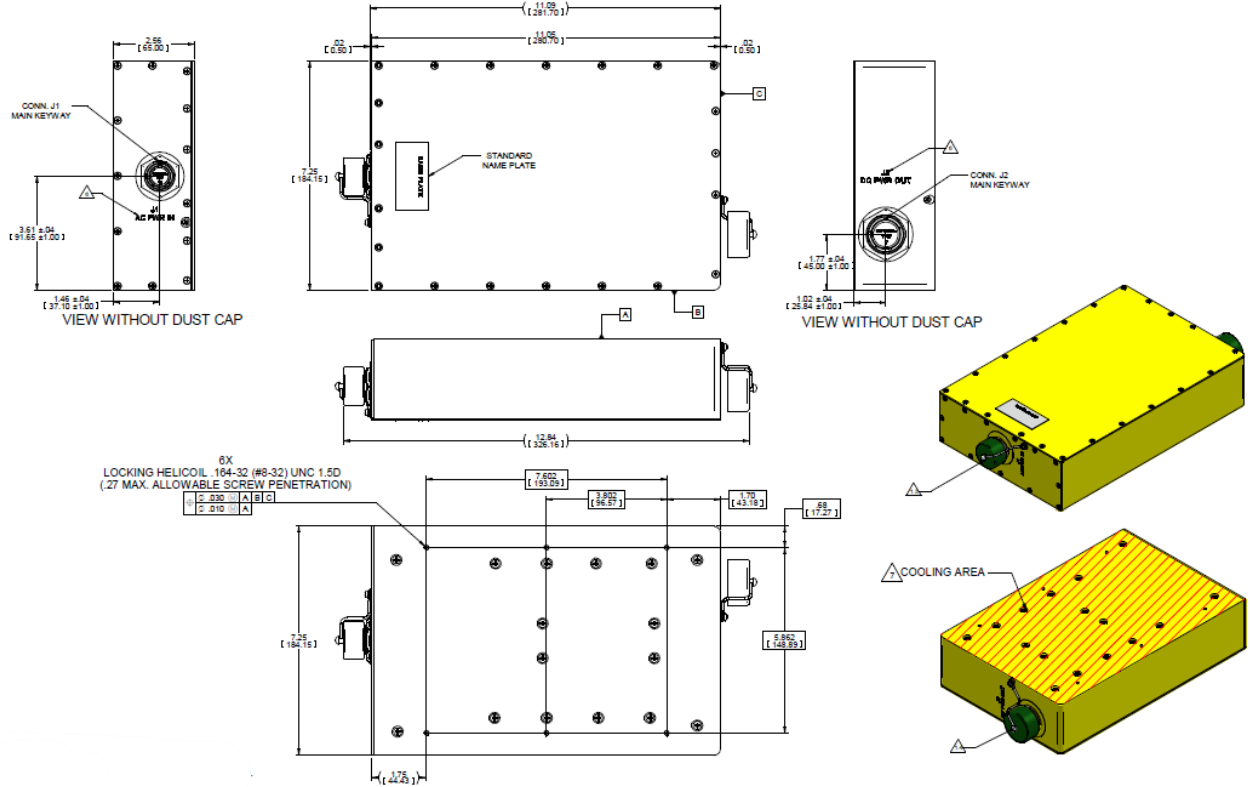

### NOTES:

1. CONNECTORS:
  - 1.1. J1- CONN. AC PWR IN, P/N D38999/24WC4PN OR EQ.
  - 1.2. J2- CONN. DC PWR OUT, P/N D38999/24WE6SN OR EQ.
  - 1.3. CONN. J1 DUST CAP, P/N D38999/33W13R OR EQ.
  - 1.4. CONN. J2 DUST CAP, P/N D38999/33W17R OR EQ.
2. MATERIAL: AL 6061-T651, AL 5052-H32, OR EQ.
3. COATINGS:
  - 3.1. CHROMATE CONVERSION COATING PER MIL-DTL-5541 TYPE II CLASS 3 CLEAR.
4. WORKMANSHIP SHALL BE MIL-STD-454, REQ. 9.
5. MAX WEIGHT: 10.5 LBS.
6. ENGRAVING:
  - 6.1. CHARACTER HEIGHT: .15 IN.
  - 6.2. CHARACTER DEPTH: .02 IN.
  - 6.3. FONT: ARIAL
  - 6.4. CHARACTER ARE CENTRALLY LOCATED.
  - 6.5. FILL ENGRAVING WITH BLACK LUSTERLESS EPOXY PAINT, COLOR PER FED-STD 595 NO. 37038.
7. COOLING:
  - HEAT DISSIPATION AREA- 80.11 [IN<sup>2</sup>]

**Please note: Specifications are subject to change without prior notice by the manufacturer.**